

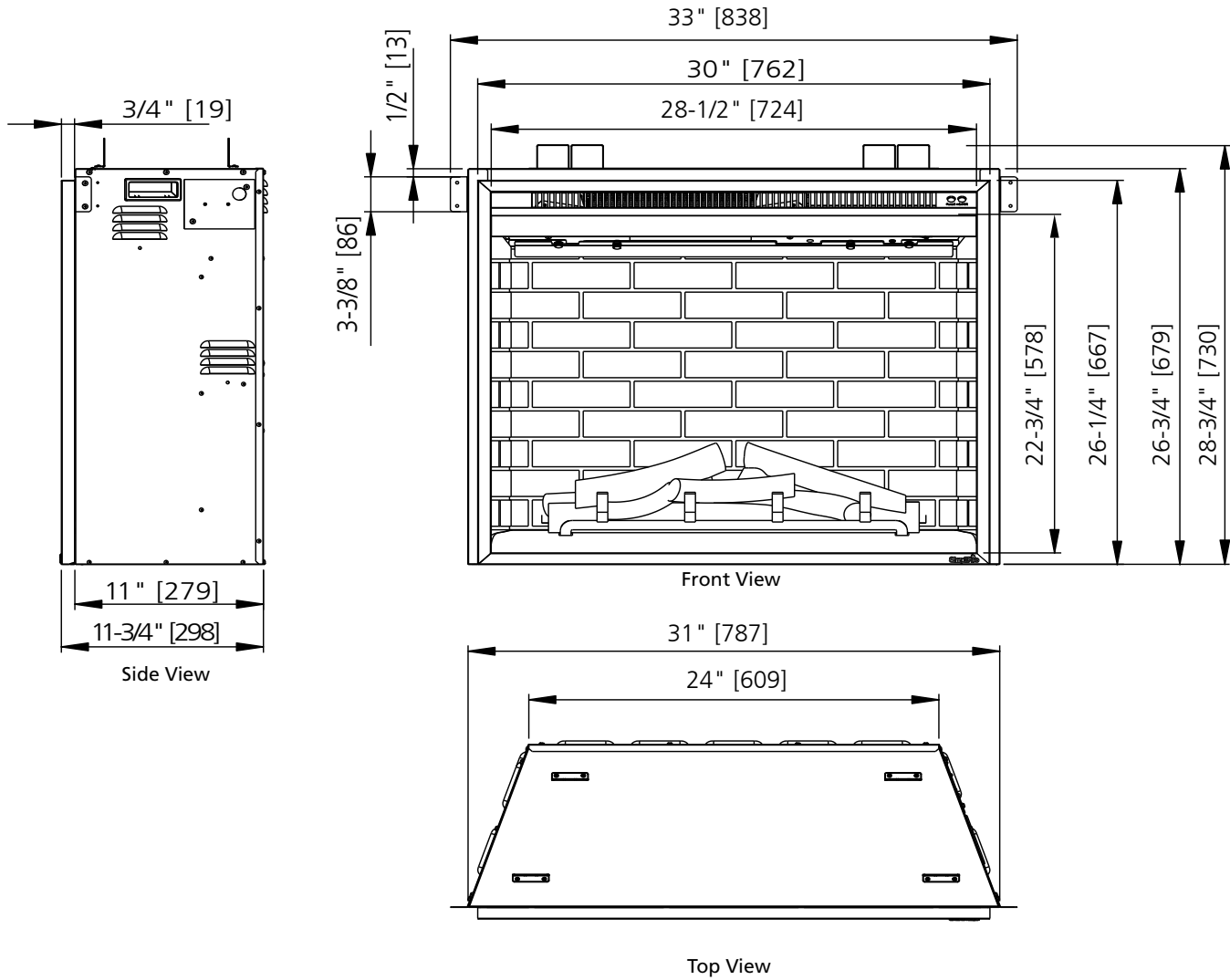

Please consult the manufacturer's installation manual for all details and requirements before making a final design layout decision.

30" Built-In Electric Fireplace

MODEL	FRONT WIDTH	BACK WIDTH	HEIGHT	DEPTH	VIEWING AREA
SF-BI30-EB	31"	24"	26-3/4"	11"	28-1/2" x 22-3/4"



MINIMUM CLEARANCES TO COMBUSTIBLES

AREA	120V	240V
SIDES	0"	0"
FLOOR	0"	0"
TOP	0"	2" [51]
BACK	0"	0"
FRONT	36" [914]	36" [914]

FINISHING DIMENSIONS

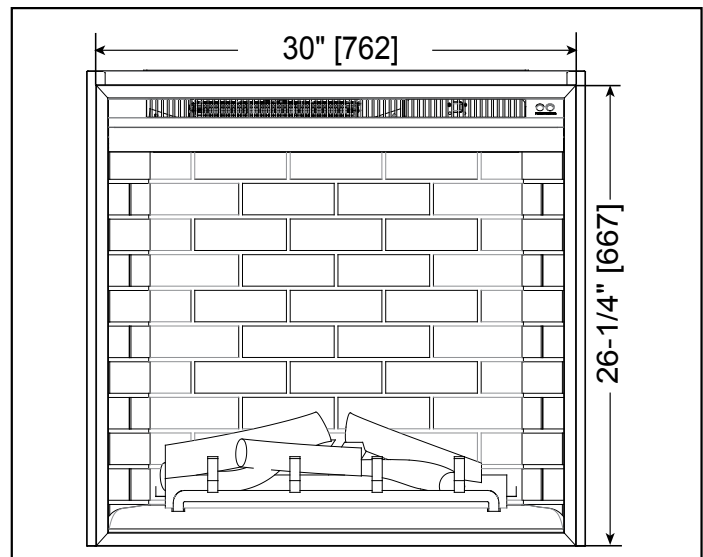

MANTEL PROJECTIONS

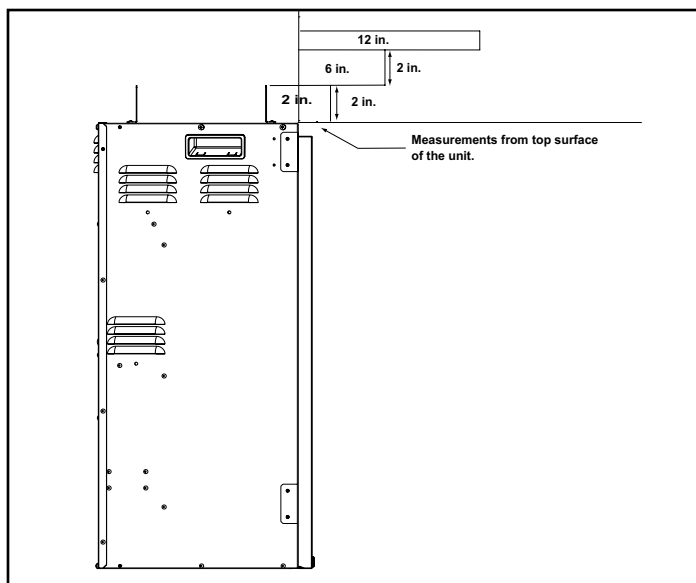

APPLIANCE LOCATION

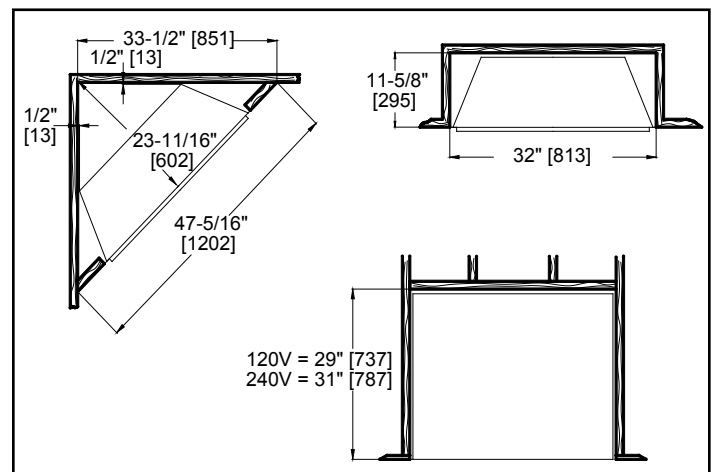

PRODUCT LISTING CODES	
US	CSA 22.2 No 46-M1988
INTERNATIONAL	CSA 22.2 No 46-M1988

Product information provided is not complete and is subject to change without notice. Product installation must adhere strictly to instructions accompanying product to avoid risk of fire and potential injury.

Additional information can be found online at www.fireplaces.com